

## MOTOR SPECIFICATIONS

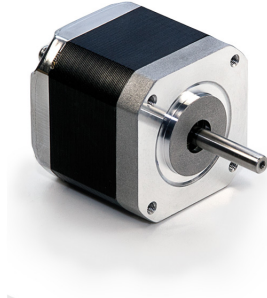

|                             |                                      |
|-----------------------------|--------------------------------------|
| <b>Part Number</b>          | <b>4418S-01</b>                      |
| <b>NEMA Size</b>            | NEMA 17                              |
| <b>Frame Size</b>           | 42.4mm (1.7 in)                      |
| <b>Step Angle</b>           | 1.8 deg/step                         |
| <b>Body Length (Dim. A)</b> | 34.3mm (1.4 in)                      |
| <b>Current</b>              | 1.7 Amps/Phase                       |
| <b>Holding Torque</b>       | 0.43 Nm (61 oz-in)                   |
| <b>Resistance</b>           | 1.6 Ohm/Phase                        |
| <b>Rotor Inertia</b>        | 53.05 g-cm <sup>2</sup> (0.29 oz-in) |
| <b>Number of Leads</b>      | 4                                    |
| <b>Connection</b>           | Bipolar                              |
| <b>Weight</b>               | 0.25 kg (0.55 lb)                    |

## DIMENSIONS

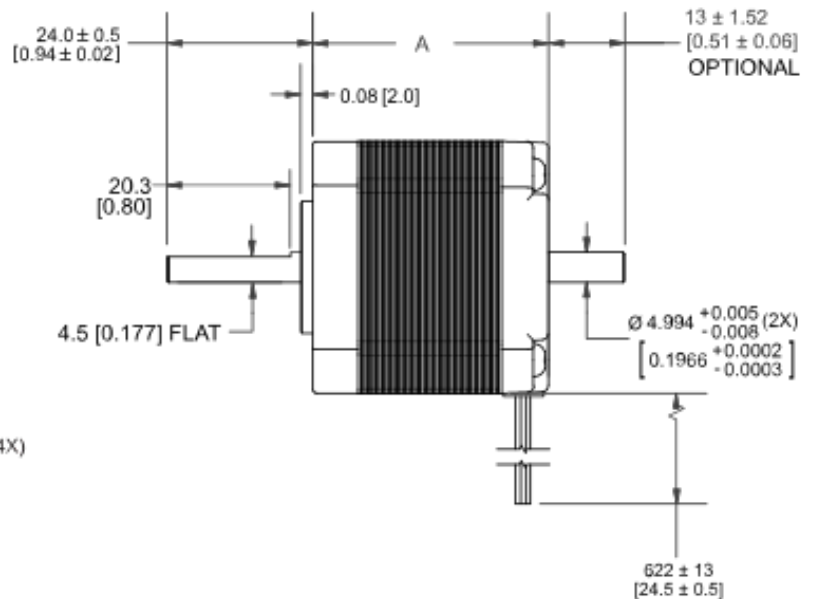
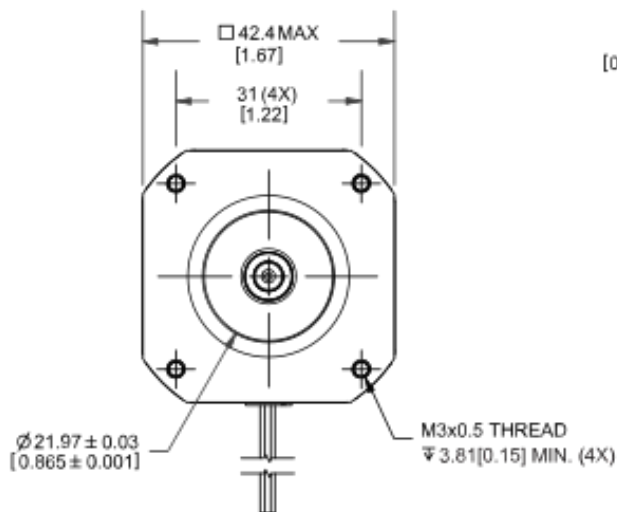

## PERFORMANCE CURVE

## OPERATING CONDITIONS

|   |   |
|---|---|
| <b>Radial Play</b>                                | 0.03 mm max @ 0.45 kg load (0.001 in max @ 1 lb load) |
| <b>End Play</b>                                   | 0.08 mm max @ 1.36 kg load (0.003 in max @ 3 lb load) |
| <b>Shaft Run Out</b>                              | 0.05 mm TIR (0.002 in TIR)                            |
| <b>Concentricity of Mounting Pilot to Shaft</b>   | 0.08 mm TIR (0.003 in TIR)                            |
| <b>Perpendicularity of Shaft to Mounting Face</b> | 0.08 mm TIR (0.003 in TIR)                            |
| <b>Max Axial Load</b>                             | 2.72 kg (6 lb)  |
| <b>Maximum Case Temperature</b>                   | 80 deg C  |
| <b>Ambient Temperature</b>                        | -20 to 50 deg C                                       |
| <b>Storage Temperature</b>                        | -20 to 100 deg C                                      |
| <b>Humidity Range</b>                             | 85% or less, non-condensing                           |
| <b>Magnet Wire Insulation</b>                     | Class B 180° C*                                       |
| <b>Insulation Resistance</b>                      | 100 Ohm at 500 VCD                                    |
| <b>Dielectric Strength</b>                        | 500 VCD for 1 min                                     |

## OPERATION & USAGE TIPS

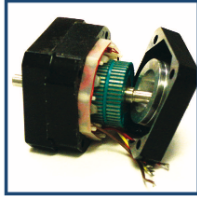

**Do not** disassemble motors; a significant reduction in motor performance will occur.

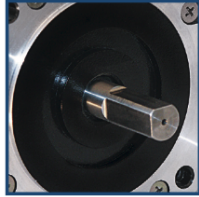

**Do not** machine shafts; this will have a negative effect on shaft run out and perpendicularity.

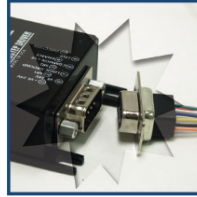

**Do not** disconnect motor from drive while in operation.

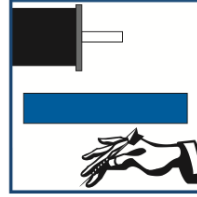

**Do not** use holding torque/detent torque of motor as a fail safe brake.

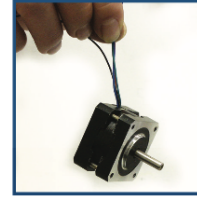

**Do not** hold motor by lead wires.



**Do not** exceed the rated current; this will burn the motor.

FAILURE TO COMPLY WITH THESE RECOMMENDATIONS WILL VOID ALL WARRANTY TERMS

## WIRING TABLE

| COLOR | FUNCTION  |
|-------|-----------|
| Red   | A+ Phase  |
| Blue  | A- Phase  |
| Green | B + Phase |
| Black | B- Phase  |

## RECOMMENDED DRIVERS/CONTROLLERS



Single Axis Controller  
+ Driver  
**R256-RO**



Microstepping Driver  
**R208**

# Motion Control, **Solved.**

## MOTOR ENGINEERING & MANUFACTURING



Optimized  
For Your  
Application



Quick  
Prototype  
Turnaround



Small Batch  
to OEM Volume  
Production



US Based  
Support &  
Manufacturing